

Installation and Operating Manual

WiseWay Model GW-1949 Pellet stove owner's manual



Picture shown with optional base tray

Table of contents:

Our commitment to safety.....	2
Accessories/ Replacement parts.....	3
Consumables.....	3
Safety Notice.....	4
Using the correct fuel.....	5
Stove pipe install hints.....	5
Lighting procedure.....	6
Temperature control.....	7
Shutting down the stove.....	7
Cleaning and Maintenance.....	7
Specifications.....	8
Helpful hints.....	10

SAVE THESE INSTRUCTIONS

The authority having jurisdiction (such as municipal building department, fire department, fire prevention bureau, etc.) should be consulted before installation to determine the need to obtain a permit.

Our commitment to safety

WiseWay pellet stoves are constructed with the utmost care and precision and designs comply with national safety standards. However, personal safety begins with good fire management.

The temperatures of surfaces in and around a fire can become extremely hot during operation. It is essential to monitor traffic around a WiseWay product to prevent burns and to protect the overall safety of your home and loved ones.

Tips for safe operation

- Always read and follow the instructions for the safe use and maintenance of your WiseWay product.
- Surfaces on stoves get EXTREMELY HOT!
- Surfaces around the fire can stay very hot for long periods of time after operation has ended. Be aware that surfaces may stay hot even if the product is not operating.
- Never leave young children or pets alone when operating a WiseWay product.
- Educate your family about fire safety before you begin operating a new WiseWay product.
- Never block free airflow through the open vents of the stove.
- Do not place clothing or other flammable items on or near the stove.
- Keep foreign objects out of the hopper.
- This stove is designed and approved for pelletized wood fuel only. Any other type of fuel burned in this heater is prohibited.
- Your stove requires periodic maintenance and cleaning. Failure to maintain your stove may lead to smoke spillage in your home.
- Allow the stove to cool before carrying out any maintenance or cleaning.

WiseWay Pellet Stoves Inc. grants no warranty, implied or stated, for the installation or maintenance of your stove, and assumes no responsibility of any consequential damage(s).

ACCESSORIES:

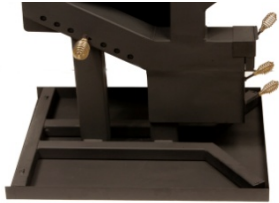

Base Pan:

Part # BP - 001



Removable wheels:

Part # RW - 001

Replacement parts and Consumables:

Primary Burn Chamber Part# APBC-12



Primary Burn cage Part# LTPBC - 001



& HTPBC_002



US 001 FOR LOWER HEAT RANGE 002 FOR HI HEAT RANGE

Ashtray Part# ATWH - 001



Secondary Burn Plate Part# SBPWH - 001

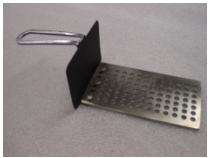

Primary Burn Chamber end slide Part# PBCSWH - 001



SAFETY NOTICE

PLEASE READ THIS ENTIRE MANUAL BEFORE INSTALLATION AND USE OF THIS PELLET FUEL-BURNING ROOM HEATER. FAILURE TO FOLLOW THESE INSTRUCTIONS COULD RESULT IN PROPERTY DAMAGE, BODILY INJURY OR EVEN DEATH.

When this room heater is not properly installed, a house fire may result. To reduce the risk of fire, follow the installation instructions. Contact local building or fire officials about restrictions and installation inspection requirements in your area.

⊖ Never use gasoline, gasoline-type lantern fuel, kerosene, charcoal lighter fluid, or similar liquids to start or “freshen up” a fire in this stove. Keep all such liquids well away from the stove while in use.

⊖ Never block free airflow through the open vents of the stove.

⊖ Keep foreign objects out of the hopper.

⊖ Hot while in operation. Keep children, clothing, and furniture away.

⊖ Contact may cause skin burns.

⊖ Educate all children of the danger of a high temperature stove. Young children should be supervised when they are in the same room as the stove.

⊖ Burning wood other than in a pellet form is prohibited

EACH UNIT HAS BEEN TESTED BEFORE LEAVING THE FACTORY SO THERE MAY BE SOME RESIDUE OF ASH OR PELLETS INSIDE.

WiseWay Pellet Stoves Inc. grants no warranty, implied or stated, for the installation or maintenance of your stove, and assumes no responsibility of any consequential damage(s).

USING THE CORRECT FUEL

- This stove is designated for burning pelletized wood fuel only. Pellet of 6.35 mm (1/4 in) in diameter and approximately 25.4 mm (1 in) long should be used.
- Burning wood in forms other than pellets is not permitted.
- **DO NOT** block the fresh air intake ports – this will seriously affect the performance of the stove.
- This stove feeds pellets at a preset rate, adding fuel by hand or burning fuel other than pellets will not increase heat output but may seriously impair the stove performance.
- **DO NOT** burn wet pellets or pellets that have been previously opened and stored in the elements. The pellets may have absorbed some moisture resulting in poor performance from the stove. Storing pellets in an air tight container is recommended.
- Stove performance depends heavily on the quality of your pellet fuel. Avoid the use of pellets which is excess fines, with binder and high ash content.

Helpful hint

When installing your stove, an all vertical stove pipe, straight up and through the roof is best. This will insure a good upward draft that all stoves need to operate. The more twists and turns you have in stove piping the more it will restrict the draft, this is true for all stoves.

IMPORTANT: It is important for the stove pipe to extend to at least as high as the highest point of your roof.

CAUTION : Don't place fuel within space heater installation clearances or within the space required for charding and ash removal

LIGHTING PROCEEDURES:

You will need a hand held propane torch to ignite your stove. We recommend a high quality propane torch with a squeeze trigger ignition system.

- Remove hopper lid. Make sure feed door is in the closed position inside of the hopper.



- Add desirable amount of pellets to the hopper.
- Make sure front dampener is in the all the way closed position (holes should be blocked)



- Inspect primary burn chamber, secondary burn plate and ashtray for soot build up and cleanliness. Perform any maintenance required.
- Reinstall primary burn chamber, secondary burn plate and ashtray.
- Remove primary burn chamber end slide located on the primary burn chamber end.

Slide cover is the top handle



- Insert lit torch into the primary burn chamber and let run for one minute, this will help start the necessary draft that all stoves need to operate and will speed the ignition process.



- Slide the feed door open, located inside the hopper and tighten set screw.
- Let torch run until temperature reaches 200 degrees, you can then remove, turn off and store your torch (this should only take one or two minutes)
- Keep the primary cover slide off until stove reaches 400 degrees

- Reinstall the primary cover slide. A drop or fluctuation in temperature after any adjustments is normal. Wait several minutes before making additional adjustments.

USE 3 OR 4 INCH STANDARD CERTIFIED PELLET EXHAUST VENTING SYSTEM TO BE INSTALLED BY CERTIFIED CHIMNEY INSTALLER AND THE STOVE INSTALLED BY A QUALIFIED STOVE INSTALLER AND THE INTSALLATION MUST MEET LOCAL CODES

WARNING : Chimney Connector must be in good condition and kept clean

DO NOT INSTALL A FLUE DAMPER IN THE EXHAUST VENTING SYSTEM OF THIS UNIT

DO NOT CONNECT THIS UNIT TO A CHIMNEY FLUE SERVING ANOTHER APPLIANCE.

Attachment and securement of the exhaust venting system to the product and to each adjoining section. All joints for connector pipe shall be required to be fastened with at least three screws. If vented horizontally, joints shall be made gastight in a manner that shall be specified.

Exhaust venting system termination requirements, including location restrictions; relationship to air inlets; distances from windows, doors, and air inlets; and distance to combustible materials MUST BE MAINTANED AT ALL TIMES

The chimney connector shall not pass through an attic or roof space, closet or similar concealed space, or a floor, or ceiling. Where passage through a wall, or partition of combustible construction is desired, the installation shall conform to CAN/CSA-B365, *Installation Code for Solid-Fuel-Burning Appliances and Equipment.*

Install only with a chimney complying with the requirements for Type HT chimneys in the Standard for Chimneys, Factory-Built, Residential Type and Building Heating Appliance, UL 103 or a code-approved masonry chimney with a flue liner

USE 3 OR 4 INCH STANDARD CERTIFIED PELLET EXHAUST VENTING SYSTEM TO BE INSTALLED BY CERTIFIED CHIMNEY INSTALLER AND THE STOVE INSTALLED BY A QUALIFIED STOVE INSTALLER AND THE INTSALLATION MUST MEET LOCAL CODES

Caution do not make make-shift compromise during installation of the chimney and stove.

INSTALL VENT AT CLEARANCES SPECIFIED BY THE VENT MAUFACTURER

**The ashtry should be slid all the way in during operation.
Seconday burn plate can be slid out as much as 1 inch to increase air flow.**

After starting the stove the primary end slide must be on to insure proper air flow through the secondary burn chamber and proper use of outside air.

**A NON-FLAMMABLE HEARTH PAD MUST BE INSTALLED
(see diagram) NON-FLAMMABLE HEATH PAD**

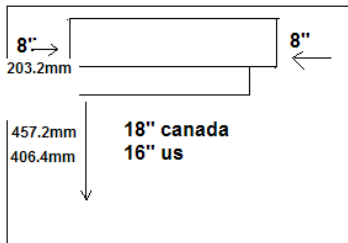

CLEARANCE TO COMBUSTIBLES

WALL CLEARANCES

A=8" (203.2 MM) B=2" (50.8MM) C=13.5" (342.9MM) D=14.5" (368.3MM) E=46.5" (1181.1MM)

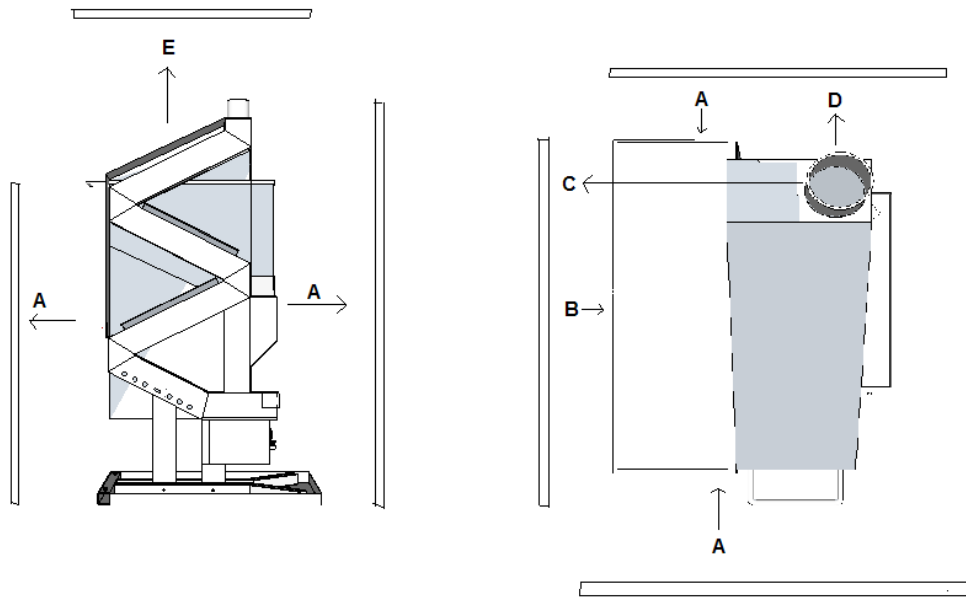

Clearances may only be reduced by means by the regulatory authority.

- the space heater is to be connected to a factory-built chimney conforming to CAN/ULC-S629, Standard for 650 C Factory-Built Chimneys,



For outside air us a dryer vent with a aluminum flex pipe and a outside screen vent cap the stove must be secured to floor

WARNING : A source of fresh air into the room or space heater shall be provided when required.

- operating the stove with the end slide plate off will burn pellets faster and outside air will not pass through the stove properly
- The possible effects of room air starvation, icing, exhaust fans, etc and the need for adequate ventilation has to be considered when running the stove
-

CAUTION : DO NOT CONNECT TO OR USE IN CONJUNCTION WITH ANY AIR DISTRIBUTION DUCTWORK UNLESS SPECIFICALLY APPROVED FOR SUCH INSTALLATIONS.

CAUTION : DO NOT USE CHEMICALS OR FLUIDS TO START THE FIRE

CAUTION : DO NOT BURN GARBAGE OR FLAMMABLE FLUIDS SUCH AS GASOLINE, NAPHTHA OR ENGINE OIL.

CAUTION : HOT WHILE IN OPERATION. KEEP CHILDREN, CLOTHING AND FURNITURE AWAY. CONTACT MAY CAUSE SKIN BURNS.

TEMPATURE CONTROL:

Because the dampener is located behind the burn chamber, adjusting the temperature is the opposite of how you would normally adjust a fire stove. Open the dampener to cool the temperature, close the dampener to increase the temperature. Open the dampener by loosening the dampener handle, counter clockwise to loosen, clockwise to tighten. **CAUTION – DO NOT OVER LOOSEN THE DAMPENER HANDLE! THIS MAY CAUSE THE HANDLE TO SEPARATE FROM THE DAMPENER PLATE.** Only turn approximately one half turn, just enough to slide the dampener plate open or closed. For maximum primary air flow slide

secondary burn plate out 1 inch for minimum primary air flow slide secondary burn plate all the way in

With the temperature control on low(holes all the way open) the temperature Guage should not fall below 300 Degrees because there will not be enough draft for the stove to operate correctly if it does.

SHUTTING DOWN THE STOVE:

When you are ready to turn your stove off, simply close the feed door located inside the hopper by loosening the set screw and sliding the door handle all the way down in the closed position. After you have closed the feed door the stove will continue to burn for approximately 45 -60 minutes.

***HINT:** Closing the dampener slide to the all the way closed position will speed this process.*

CLEANING AND MAINTNANCE:

WARNING : DO NOT use substitute materials

WARNING : DO NOT CLEAN WHILE HOT!

Establish a routine for the fuel, wood burner and firing technique. Check daily for creosote build-up until experience shows how often you need to clean to be safe. Be aware that the hotter the fire the less creosote is deposited, and weekly cleaning may be necessary in mild weather even though monthly cleaning may be enough in the coldest months. Contact your local municipal or provincial fire authority for information on how to handle a chimney fire. Have a clear understood plan to handle a chimney fire.

Creostoe – Formation and Need for Removal –

When wood is burned slowly, it produces tar and other organic vapors and these combine with expelled moisture to form creosote. The creosote vapors condense in the relatively cool chimney flue associated with a slow burning fire. As a result, creosote residue accumulates on the flue lining. When ignited, this creosote can result in an extremely hot fire;

The chimney should be inspected periodically during the heating season to determine if a creosote build-up has occurred. If a significant layer of creosote has accumulated (3mm or more) it should be removed to reduce the risk of a chimney fire.

Disposal of Ashes –

Ashes should be placed in a steel container with a tight fitting lid. The closed container of ashes should be placed on a noncombustible floor or on the ground, well away from all combustible materials, pending final disposal. If the ashes are disposed of by burial in soil or otherwise locally dispersed, they should be retained in the closed container until all cinders have been thoroughly cooled.

Never use gasoline, gasoline-type lantern fuel, kerosene, charcoal light fluid, or similar liquids to start or 'freshen up' a fire in this heater. Kepp all such liquids well away from the heater while it is in use.

Soot and Flyash : Formation and Need for Removal –

The products of combustion will contain small particles of flyash. The flyash will collect in the exhaust venting system and restrict the flow of the flue gases. Incomplete combustion, such as occurs during startup, shutdown, or incorrect operation of the room heater will lead to some soot formation which will collect in the exhaust venting system. The exhaust venting system should be inspected at least once every year to determine if cleaning is necessary.

NOTE: Failure to keep a clean burn chamber can result in poor stove performance.

Combustible Wall Chimney Connector Pass-Throughs

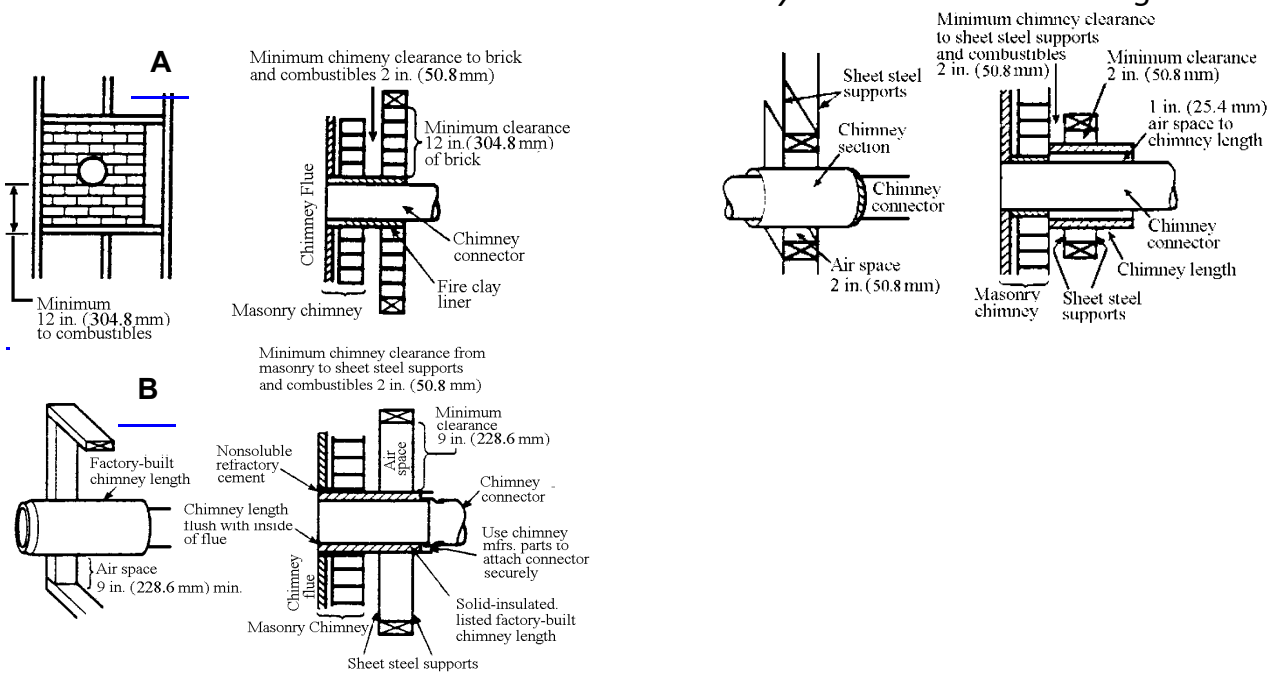

Method A. 12" (304.8 mm) Clearance to Combustible Wall

Member: Using a minimum thickness 3.5" (89 mm) brick and a 5/8" (15.9 mm) minimum wall thickness clay liner, construct a wall pass-through. The clay liner must conform to ASTM C315 (Standard Specification for Clay Fire Linings) or its equivalent. Keep a minimum of 12" (304.8 mm) of brick masonry between the clay liner and wall combustibles. The clay liner shall run from the brick masonry outer surface to the inner surface of the chimney flue liner but not past the inner surface. Firmly grout or cement the clay liner in place to the chimney flue liner.

Method B. 9" (228.6 mm) Clearance to Combustible Wall

Member: Using a 4" (152.4 mm) inside diameter, listed, factory-built Solid-Pak chimney section with insulation of 1" (25.4 mm) or more, build a wall pass-through with a minimum 9" (228.6 mm) air space between the outer wall of the chimney length and wall combustibles. Use sheet metal supports fastened securely to wall surfaces on all sides, to maintain the 9" (228.6 mm) air space. When fastening supports to chimney length, do not penetrate the chimney liner (the inside wall of the Solid-Pak chimney). The inner end of the Solid-Pak chimney section shall be flush with the inside of the masonry chimney flue, and sealed with a non-water soluble refractory cement. Use this cement to also seal to the brick masonry penetration.

Method C. 2" (50.8 mm) Clearance to Combustible Wall

Member: Start with a solid-pak listed factory built chimney section at least 12" (304 mm) long, with insulation of 1" (25.4 mm) or more, and an inside diameter of 6" (2 inches [51 mm] larger than the 4" [152.4 mm] chimney connector). Use this as a pass-through for a minimum 24-gage single wall steel chimney connector. Keep solid-pak section concentric with and spaced 1" (25.4 mm) off the chimney connector by way of sheet metal support plates at both ends of chimney section. Cover opening with and support chimney section on both sides with 24 gage minimum sheet metal supports. See that the supports are fastened securely to wall surfaces on all sides. Make sure fasteners used to secure chimney flue liner.

NOTES:

1. Connectors to a masonry chimney, excepting method B, shall extend in one continuous section through the wall pass-through system and the chimney wall, to but not past the inner flue liner face.

2. A chimney connector shall not pass through an attic or roof space, closet or similar concealed space, or a floor, or ceiling

Specifications:

Model.....GW-1949

Height..... 52”

Width.....24”

Depth.....15”

Weight.....113lbs

Hopper Capacity.....40lbs

Helpful Hints:

- Keep foreign debris out of the hopper.
- When stove is not in use, take the opportunity to clean and inspect the primary burn chamber, secondary burn plate and ash tray.
- Always store opened pellet bags in an airtight container; this will maximize the life of stored pellets.
- Starting the draft by heating the primary burn chamber is recommended and will speed the ignition process. When the stove is cold, and it is colder outside than it is inside, there is a downward draft in a chimney. By running the torch for a minute it overcomes the downward draft and starts an upward draft. You can tell if you have an upward draft by placing your hand in front of the primary burn chamber opening (after you have run the torch for approximately one minute). If you don't feel any heat coming out of the end of the primary burn chamber then you have an upward draft and can open the feed door, in the hopper, and let the pellets fill the primary burn chamber.
- Pellets made from Douglass Fir are the hottest burning pellet and are recommended.

- If smoke becomes present during ignition, reposition the torch head so the flame burns across the bottom portion of the burn cage not directly on the burn cage.
- When installing your stove, an all vertical stove pipe, straight up and through the roof is best. This will insure the best upward draft that all stoves need to operate. The more twists and turns you have in stove piping the more it will restrict the draft, this is true for all stoves.

IMPORTANT: It is important for the stove pipe to extend to at least as high as the highest point of your roof.

LABEL

Tested & Listed By **C O-T L US** Portland Oregon USA
 OMNI-Test Laboratories, Inc.
 Report #Rapport # 504-S-01-2
 Tested to Tests: ULC-S827-00, and UL 1482-2011

MODEL / MODÈLE: GW1949
 Room Heater Solid Wood Fuel Type
 This pellet burning appliance is also listed for use in Manufactured Homes in accordance with OAR 814-23-900 through 814-23-909

Serial Number / Numéro de Série

Wise Way PELLET STOVES

Appareil de chauffage de pièce agréé, h
 Cet appareil de chauffage à granulés a été
 maisons préfabriquées, conformément aux no
 de l'OAR.

"PREVENT HOUSE FIRES"

Install and use only in accordance with manufacturer's installation and operation instructions. Contact local building or fire officials about restrictions and inspection in your area.

Use a 3" or 4" diameter type "L" or "PL" venting system.

Do not connect this unit to a chimney flue servicing another appliance.

For Use With Pelletized Wood Fuel Only.
 Do not use any other type of fuel.

Input Rating Max: 5.5 lb. fuel/hr.

Do not obstruct the space beneath the heater.

For further instruction, refer to owner's manual.

Keep viewing, fuel loading, and ash removal doors closed during operation.

Inspect and Clean Chimney Frequently – Under Certain Conditions of Use, Creosote Buildup May Occur Rapidly.

MINIMUM CLEARANCES TO COMBUSTIBLES:

- A = 8 inches / 203 mm
- B = 2 inches / 51 mm
- C = 13.5 inches / 343 mm
- D = 14.5 inches / 369 mm
- E = 46.5 inches / 1182 mm

Use a non-combustible (2.24k or lower) floor protector extending under the unit and to the sides, front and back of unit as shown in Floor Protection Diagram. Measure front distance from the surface of the glass door.

Recommended: Non-combustible floor protection extending beneath any horizontal sections of venting, including the "T" on the back when venting vertically.

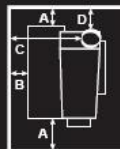

FLOOR PROTECTOR / PROTECTION DU PLANCHER

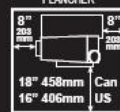

"PREVENTION DES INCENDIES"

Respecter scrupuleusement les instructions du constructeur pour l'installation et les consignes de fonctionnement. respecter les règles de sécurité en vigueur dans votre région.

Utiliser des tuyaux «Spécial granulés» de Ø76 mm ou 102 mm. Ne pas raccorder ce poêle à un conduit de cheminée déjà utilisé pour un autre appareil.

Pour usage avec les boulettes de bois.

N'utiliser aucun autre genre de combustible.

ASTM E1509-ULC-C1482-M1990

Appareil de chauffage à granulé type (UM) 84-HUD. Consommation maximum: 2.5 tgh.

Ne pas bloquer l'espace au dessous de l'appareil.

Pour une information plus complète, se reporter à la notice d'utilisation. Tenir la porte hermétiquement close durant fonctionnement.

Inspectez et nettoyez la cheminée fréquemment. Sous certaines conditions, il se peut que la créosote s'accumule rapidement.

Tests ré
 LABOR
 Report

MINIM
 TO C

A = 2
 B =
 C = 34
 D = 36
 E = 116

Utiliser une prot
 (2.24k) dépassa
 l'arrière et le dé
 schéma. La mes
 la vitre frontale
 protection de so
 tuyau de fumée
 horizontale direc

US ENVIRONMENTAL PROTECTION AGENCY
 This model is exempt from EPA certification under 40 CFR 60.531 by definition [Wood Heater (A) "Air-to-Fuel Ratio"]

Made in U.S.A. of US and imported parts. / Fabriqué aux Etats-Unis-d'Amérique par de pièces d'origine américaine et pièces importées.
 DO NOT REMOVE THIS LABEL / NE PAS ENLEVER L'ÉTIQUETTE

Agence Américaine pour la Protection de l'Environnement
 Ce modèle est dispensé par EPA certification d'après 40 CFR 60.531 par définition [Appareil à bois (A) «Ratio

Date of Manufacture / Date de fabrication:
 2012 2013 2014 JAN FEB MAR APR MAY JUN JUL AUG SEP OC
 Fabriqu par: WiseWay Pellet Stoves, P.O. Box 2151 • Harbor, OR 97136

CAUTION: HOT WHILE IN OPERATION. DO NOT TOUCH. KEEP CHILDREN, CLOTHING AND FURNITURE AWAY. CONTACT MAY CAUSE SKIN BURNS. SEE NAMEPLATE AND INSTRUCTIONS.



ATTENTION: CHAUD LORS DE L'OPÉRATION. NE GARDEZ LES ENFANTS, LES VÊTEMENTS ET LES MEUBLES L'ESPACE DÉSIGNÉ DE L'INSTALLATION. LE CONTACT PEUT BRÛLURES À LA PEAU. VOIR L'ÉTIQUETTE ET LES INSTRUC

WISEWAY PELLET
 12-4892